

SEKSIYONEL KAPILAR



GOXU
— World Wide Open —

İÇİNDEKİLER

Sayfa İÇİNDEKİLER

Sayfa

SEKSİYONEL GARAJ KAPILARI	4
SEKSİYONEL CAM KAPILAR	16
SEKSİYONEL SANAYİ KAPILARI	22



Her zaman önde!
konut, ticari ve sanayi
otomatik kapı üretiminde
30 yıllık tecrübe ile...





➤ **Seksiyonel
Garaj Kapıları**

ev gibisi var mı?

*insanın kendisini rahat, güvenli ve huzurlu hissettiği yer evidir.
bu duyguyu “seksiyonel garaj kapıları” da
tamamlamalı ve desteklemelidir..*

GOXU
— World Wide Open —

ev keyiflidir...

geniş renk ve dokulu panel seçenekleri;
kapınızı daha keyifle kullanmanızı sağlayacaktır.



Beyaz Panel için Opsiyonel Renkler



İlave bedelle tüm RAL renklerinde (fosforlu renkler hariç) akrilik boya yapılabilir.

RAL 3020

RAL 1018

RAL 5005

RAL 7016

NOT: Sipariş adedi ve termin süresine bağlı olarak yukarıdaki 4 renk için boyama maliyeti oluşmamaktadır.

Boyalı Panel Dış Yüzey Yapısı

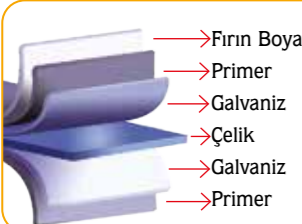

Panel Yapıları

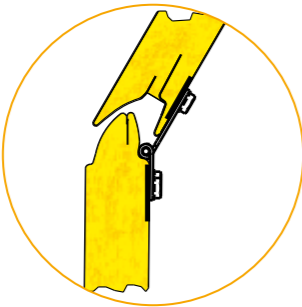

Parmak Sıkıştırma Emniyetli, Dolgulu Panel

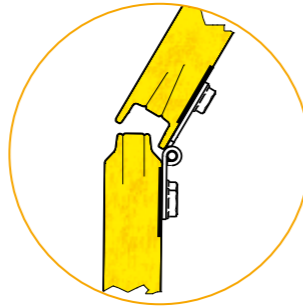

Parmak Sıkıştırma Emniyeti Olmayan, Dolgulu Panel

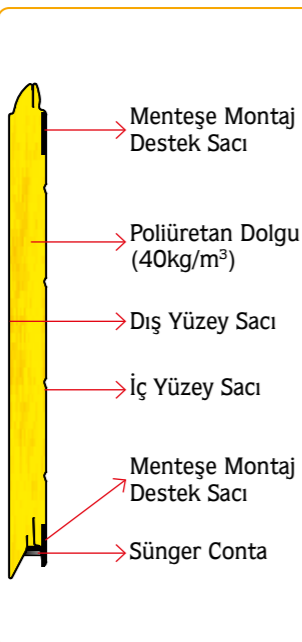

Panel İç Yüzeyleri Seçenekleri



Gofrajlı Oluklu

RAL 9010



Gofrajlı Oluklu

RAL 9002



Panel Dış Yüzey Seçenekleri

4010



Ahşap Dokulu Göbekli

RAL 9010

4011



Ahşap Dokulu Oluklu

RAL 9002 RAL 9006 RAL 7016

4012



Desensiz Düz

RAL 9010

4013



Ahşap dokulu, oluklu, Parmak Sıkıştırma emniyeti olmayan

RAL 9002 RAL 9006 RAL 7016

4015



Ahşap dokulu, oluklu, Alüminyum

RAL 9010

4016



Ahşap Doku ve Görünümlü Göbekli

Altın Meşe (PMT25)

4017



Ahşap Doku ve Görünümlü Oluklu

Altın Meşe (PMT25)

4018



Ahşap görünümlü, Desensiz (düz), ortadan tek ince oluklu

Altın Meşe (PMT25)

4023



Ahşap görünümlü, Desensiz (düz), ortadan tek kalın oluklu

Altın Meşe (PMT25)

4025



Gofrajlı, Mikrokanallı

RAL 9002 RAL 7016

ev değerlidir...

yenilikçi ürünler;

uzun ömür, güvenlik ve esneklik ile değer katar



Standart Servis Kapısı



Duvara Gömme Kapı Uygulaması



Yandan Girişli Servis Kapısı Uygulaması



Düşük Eşikli Servis Kapısı Uygulaması



Servis Kapısı Aksesuarları

Panik Bar



Hidrolik Kapı Kapatıcı



Düşük Mesafe Tutamak



Standart ve Düşük Eşikli Servis Kapısı Detayları

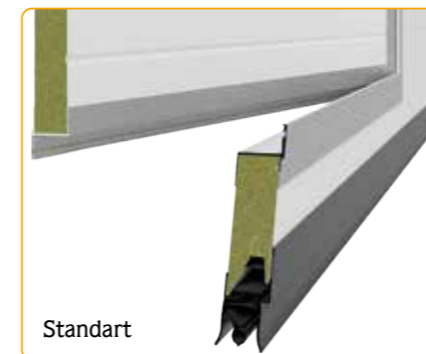

Standart

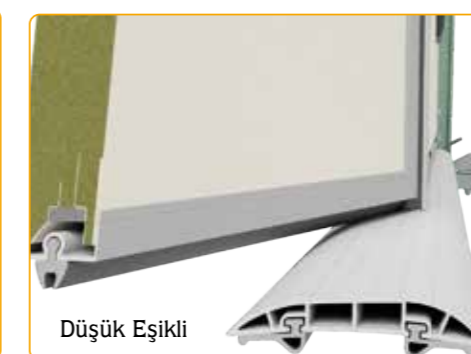

Düşük Eşikli



servis kapısı, hızlı, kolay geçiş ve enerji tasarrufu sağlar!

ev rahattır...

geniş pencere, cam ve desen seçenekleri;

- doğal ışıktan faydalanmanızı sağlar
- hayatınıza konfor katar



Konut Tipi Plastik Pencere

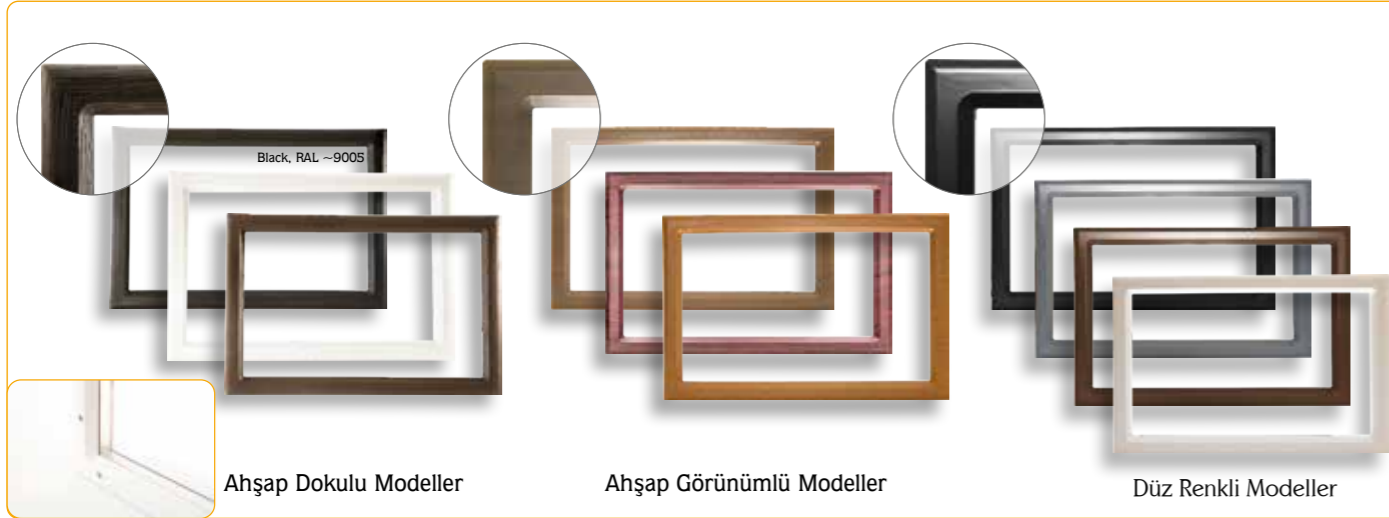

Konut Tipi Çelik Pencere

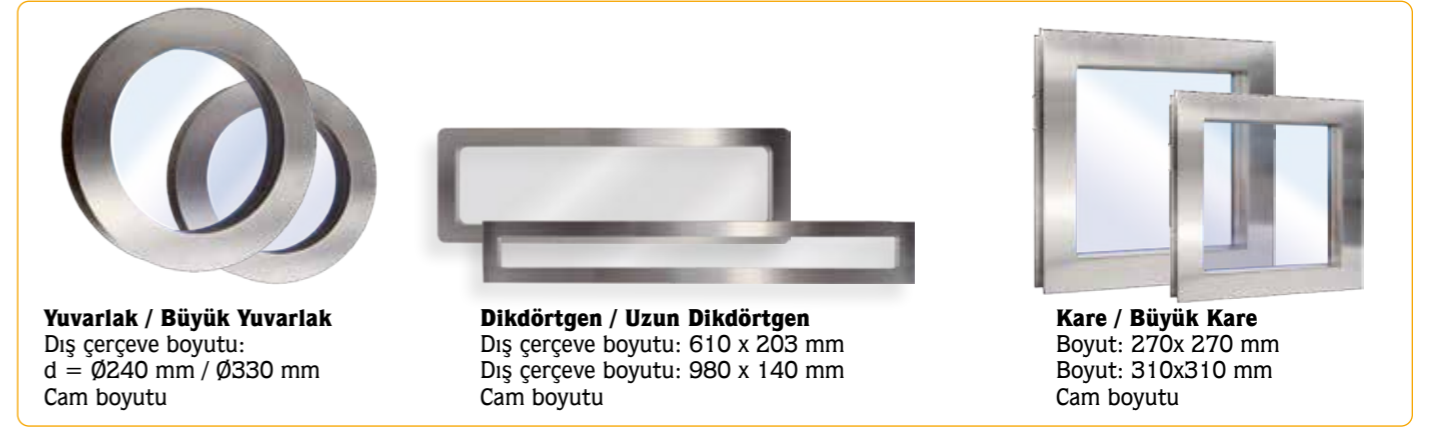

Dekoratif Pencere

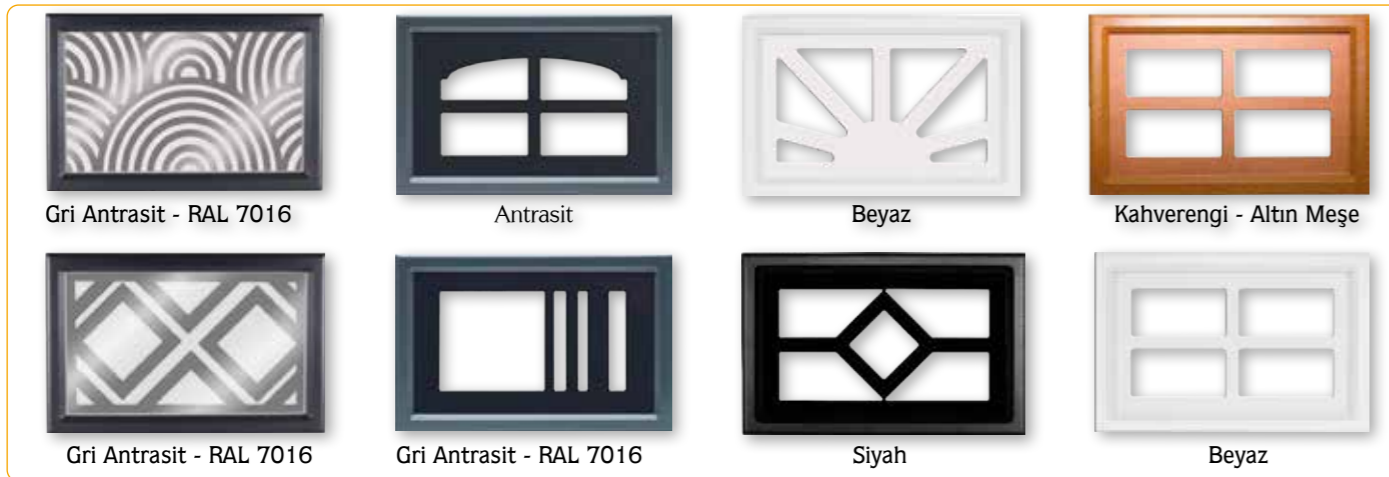

Cam Seçenekleri

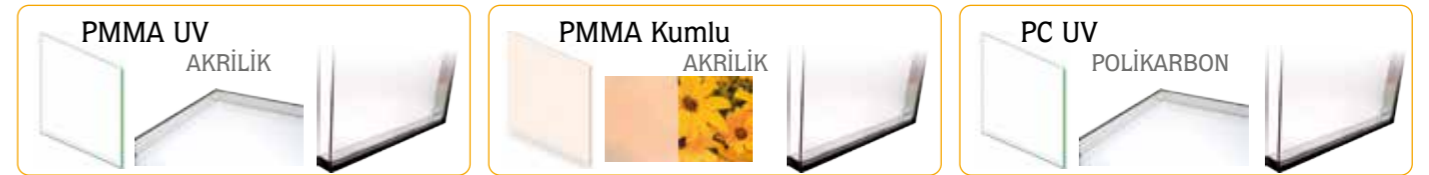

Dekoratif Uygulamalar

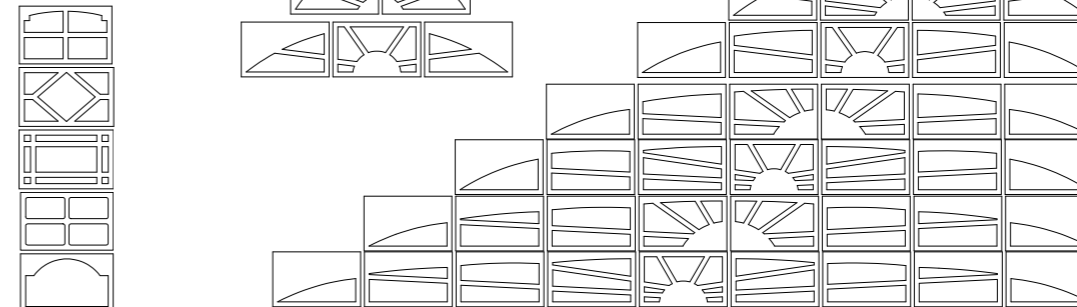

Havalandırma Izgarası



*teknoloji,
güvenlik,
esneklik...*

*güvenlik, konfor, yalıtım
ve kullanım kolaylığı için çözümler*



Kapı Kolları ve Kilitler



Yalıtım Çözümleri



Alt Conta (EPDM-Siyah)



Üst Conta (EPDM -Siyah)

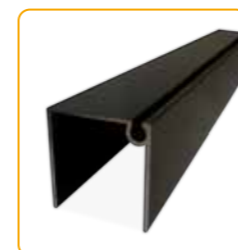

Elektrostatik Boyalı Torsiyon Yay (Standart)

Ekipman Seçenekleri



Galvanizli Ekipman:
BASE ve SAFE model için standart
Boyalı Ekipman:
LUX ve PRESTIGE model için standart
Paslanmaz Çelik Ekipman:
Tüm modeller için opsiyonel



Emniyet Sistemleri



hayatınızı
kolaylaştırın...

motor ve tamamlayıcı aksesuarlar
garaj kapınızdan tam faydalanmanızı sağlar



A1250



ARGO



SPIN



SO2000

Çalışma Prensibi



Yataklama Tipleri

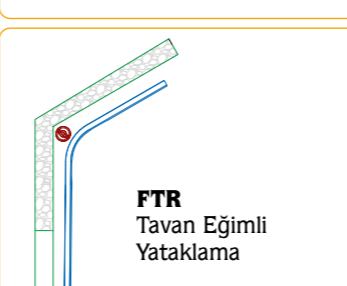
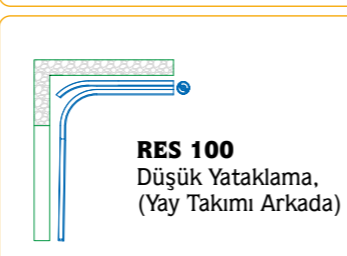
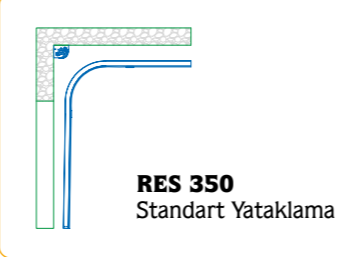

Aksesuarlar





➤ **Seksiyonel
Cam Kapılar**

*şeffaflık ile
bir adım önde*

*kontrolü elinizde tutmak çok önemlidir
“seksiyonel cam kapılar”
sizi bu yönde destekler*



*cam hayatın
her yerinde*

*kapularınıza ve yapılarınıza
cam'ın şıklığı yansısın*



Panel Yapıları

Kapı Tasarım Seçenekleri

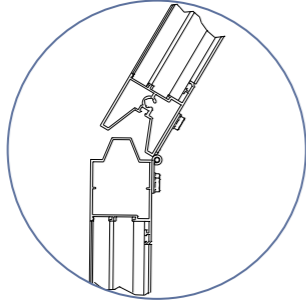
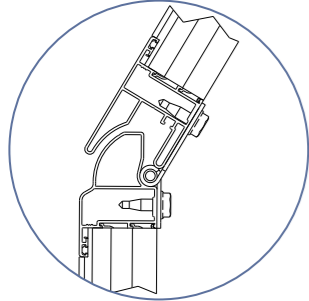

Parmak Sıkıştırma Emniyetli, Tam Görüşlü (Fullvision) Panel

Parmak Sıkıştırma Emniyeti Olmayan, Tam Görüşlü (Fullvision) Panel

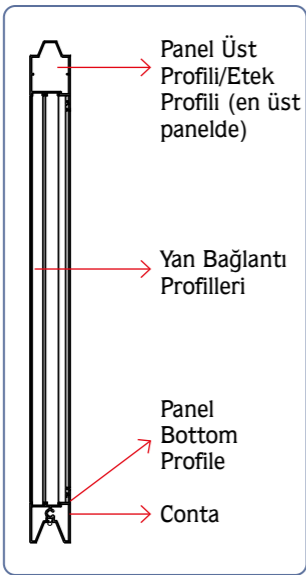
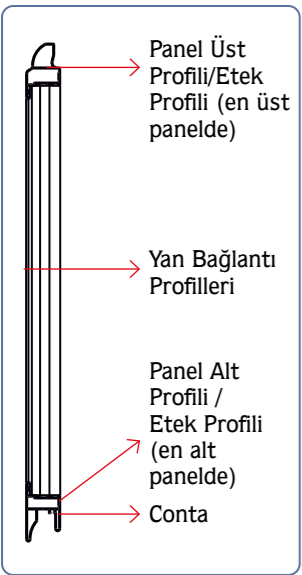

Panel Dolgu Seçenekleri

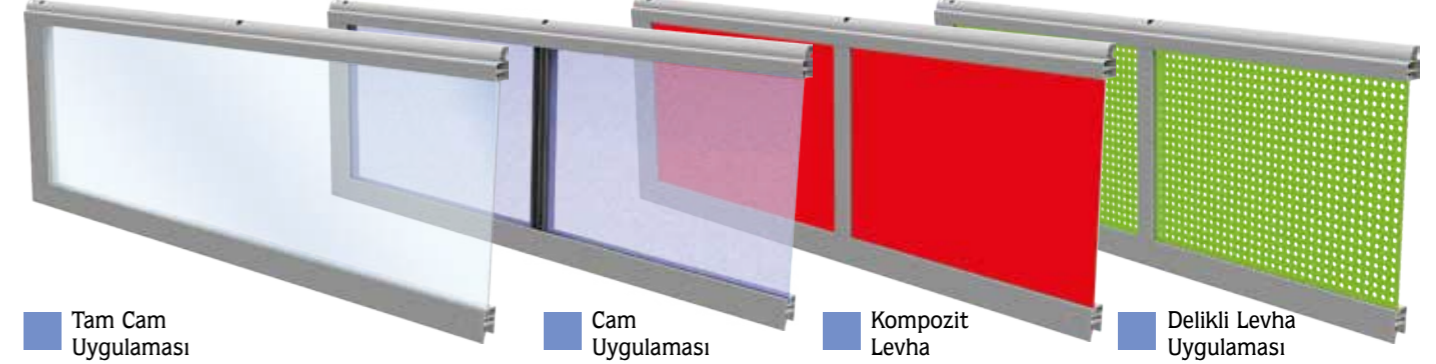

Panel Detay/Seçenekler

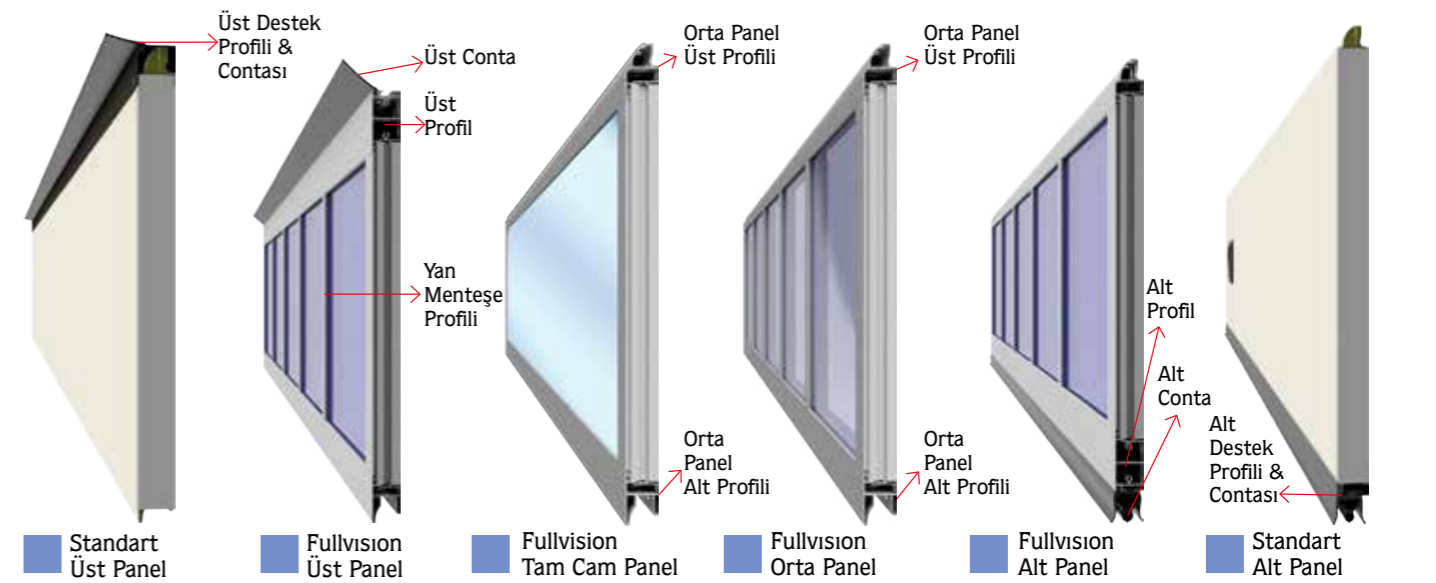

*iş şeffaflığına
ihtiyaç duyar..*

*şeffaflık için çözümler,
gün ışığı geçirgenliği ve zarif dış görünüş*



CAM SEÇENEKLERİ

AKRİLİK **PMMA UV**

Malzeme Özelliği
Renksiz, transparan, pürüzsüz, UV ışınlarına dayanıklı. Işık geçirgenliği %93. Malzeme çizilmelere dayanıklı değildir.

Levhanın kalınlığı
2,5 mm, 3,0 mm

Sınıfı
Standart ürün

AKRİLİK **PMMA UV Milk**

Malzeme Özelliği
UV ışınlarına dayanıklı. Işık geçirgenliği %4

Levhanın kalınlığı
3,0 mm

Sınıfı
Standart olmayan ürün

AKRİLİK **PMMA UV Gray**

Malzeme Özelliği
UV ışınlarına dayanıklı. Işık geçirgenliği %51

Levhanın kalınlığı
3,0 mm

Sınıfı
Standart olmayan ürün

AKRİLİK **PMMA UV Satin**

Malzeme Özelliği
UV ışınlarına dayanıklı. Işık geçirgenliği %78

Levhanın kalınlığı
3,0 mm

Sınıfı
Standart olmayan ürün

AKRİLİK **PMMA UV Soft Blue**

Malzeme Özelliği
UV ışınlarına dayanıklı. Işık geçirgenliği %88

Levhanın kalınlığı
3,0 mm

Sınıfı
Standart olmayan ürün

AKRİLİK **PMMA UV Smoked**

Malzeme Özelliği
UV ışınlarına dayanıklı. Işık geçirgenliği %50

Levhanın kalınlığı
3,0 mm

Sınıfı
Standart olmayan ürün

AKRİLİK **PMMA UV Hard**

Malzeme Özelliği
Renksiz, transparan, pürüzsüz, çizilmelere ve UV ışınlarına dayanıklı. Işık geçirgenliği %90.

Levhanın kalınlığı
2,0 mm, 2,3 mm, 3,0 mm

Camın toplam kalınlığı
15 - 31 mm

AKRİLİK **PMMA UV Bark**

Malzeme Özelliği
Renksiz, kabuk yüzey yapısı ile görüntüyü bulanıklaştırır, UV ışınlarına dayanıklı. Işık geçirgenliği %93. Malzeme çizilmelere dayanıklı değildir.

Levhanın kalınlığı
4,0 mm

Sınıfı
Standart ürün

POLİKARBON **PC UV**

Malzeme Özelliği
Renksiz, transparan, pürüzsüz, UV ışınlarına dayanıklı. Işık geçirgenliği %86. Malzeme çizilmelere dayanıklı değildir.

Levhanın kalınlığı
1,5 mm, 3,0 mm

Camın toplam kalınlığı
15 - 32 mm



➤ **Seksiyonel Sanayi Kapıları**

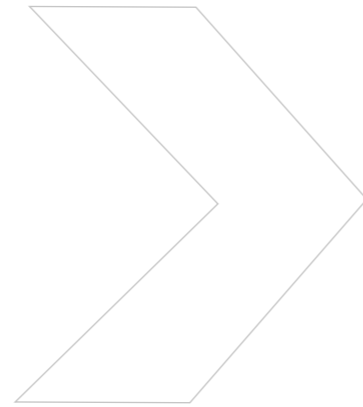

iş, ciddiyet ister!

*işiniz ve işyerinizin her bir parçası, bir zincirin halkaları gibidir,
“seksiyonel sanayi kapıları” da
güçlü halkalardan biri olmalı...*



GOXU
— World Wide Open —

*iş, verimlilik
ister..*

*hız ve tasarruf sağlayan,
farklı tip panel ve kapı seçenekleri*



**Beyaz Panel için
Opsiyonel Renkler**



İlave bedelle
tüm RAL renklerinde
(fosforlu renkler hariç)
akrilik boya yapılabilir.

RAL 3020

RAL 1018

RAL 5005

RAL 7016

NOT: Sipariş adedi
ve termin süresine bağlı
olarak yukarıdaki 4 renk
için boyama maliyeti
oluşmamaktadır.

**Boyalı Panel Dış
Yüzey Yapısı**

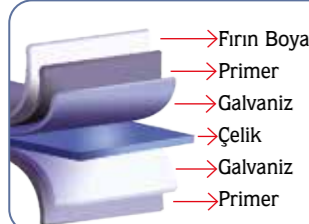

**Panel
Yapıları**

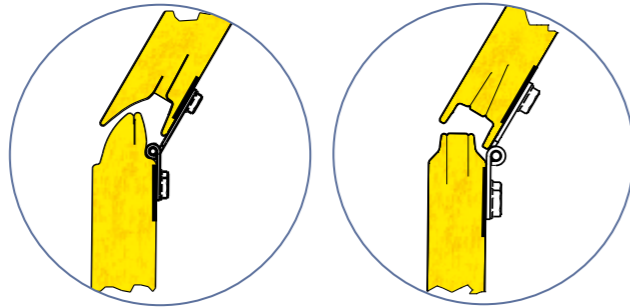

Parmak Sıkıştırma
Emniyetli,
Dolgulu Panel

Parmak Sıkıştırma
Emniyeti Olmayan,
Dolgulu Panel

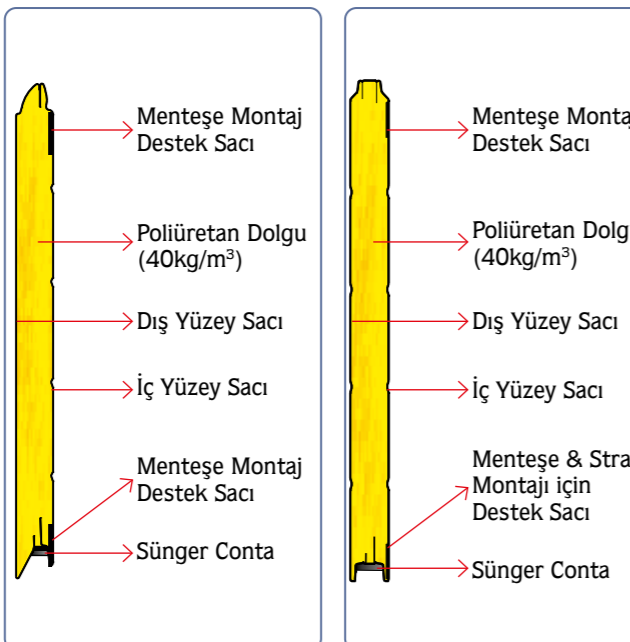

**Panel İç Yüzey
Seçenekleri**



Gofrajlı Oluklu

RAL 9010



Gofrajlı Oluklu

RAL 9002



**Panel Dış Yüzey
Seçenekleri**

4010



Ahşap Dokulu
Göbekli

RAL 9010

4011



Ahşap Dokulu
Oluklu

RAL 9002 RAL 9006 RAL 7016

4012



Desensiz
Düz

RAL 9010

4013



Ahşap dokulu, oluklu,
Parmak Sıkışma
emniyeti olmayan

RAL 9002 RAL 9006 RAL 7016

4015



Ahşap dokulu,
oluklu, Alüminyum

RAL 9010

4016



Ahşap Doku ve
Görünümlü
Göbekli

Altın Meşe (PMT25)

4017



Ahşap Doku ve
Görünümlü
Oluklu

Altın Meşe (PMT25)

4018



Ahşap görünümlü,
Desensiz (düz), ortadan
tek ince oluklu

Altın Meşe (PMT25)

4023



Ahşap görünümlü,
Desensiz (düz),
ortadan tek kalın
oluklu

Altın Meşe (PMT25)

4025



Gofrajlı,
Mikrokanallı

RAL 9002 RAL 7016

*iş teknolojiye
ihtiyaç duyar...*

*yüksek teknoloji üretim prosesi
uzun ömür, güvenlik ve esneklik sağlar*



**Standart
Servis Kapısı**



**Duvara Gömme
Kapı Uygulaması**



**Yandan Girişli Servis
Kapısı Uygulaması**



**Düşük Eşikli
Servis Kapısı Uygulaması**



**Servis Kapısı
Aksesuarları**

Panik Bar

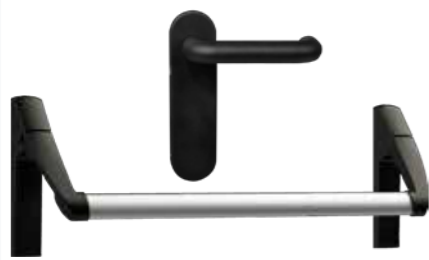

Hidrolik Kapı Kapatıcı



Düşük Mesafe Tutamak



**Standart ve Düşük Eşikli
Servis Kapısı Detayları**

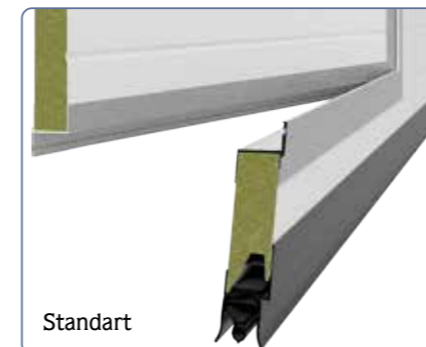

Standart

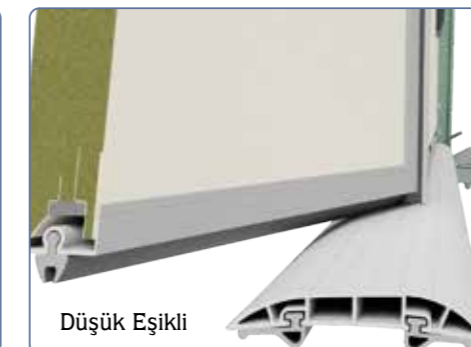

Düşük Eşikli



servis kapısı, hızlı, kolay geçiş ve enerji tasarrufu sağlar!

*iş, dikkat
gerektirir...*

*her parçaya gösterilen dikkat ve özen,
işin bütününe de
mükemmelliğini sağlar...*

Yaylar



Elektrostatik
Boyalı
Torsiyon Yay
(Standart)

Yay Kırılma
Emniyet
Sistemi



Gürültü azaltıcı etkili
yay doğrultucu

Yay
Takoza

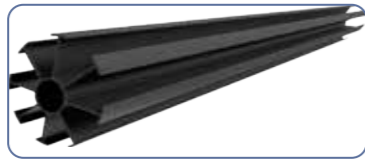

YAY ÖMRÜ
Standart 20.000
çalışma turu
(Opsiyonel 100,000
tura kadar)



Kumlanmış ağır hizmet yayları
Paslanmaz elektrostatik boyalı yaylar

Kapı Kolları ve Kilitler



Yüze
Montaj Tip
Kapı Kolu



Manuel
Yan
Kilit



Manuel
Merkezi
Kilit

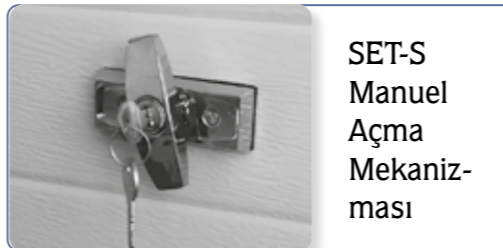

SET-S
Manuel
Açma
Mekaniz-
ması

Yalıtım Çözümleri



Termoplastik
Yan Conta (Siyah)

Alt Conta
(EPDM-Siyah)



Alt Alüminyum
Taşıyıcı Profil (Siyah)



Üst Conta
(EPDM -Siyah)



Üst Alüminyum
Taşıyıcı Profil (Siyah)



Ekipman Seçenekleri



Galvanizli Ekipman:
Tüm modeller için standart

Boyalı Ekipman:
Tüm modeller için opsiyonel

Paslanmaz Çelik Ekipman:
Tüm modeller için opsiyonel

Ray
Askı
Aparatı
(Opsiyonel)

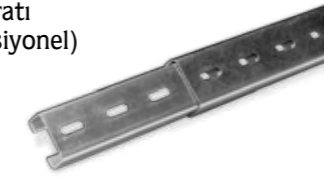

Emniyet Sistemleri



Yay Kırılma Emniyet Sistemi
HERO Model için standart



Halat Kopma Emniyet
Sistemi
(Opsiyonel)



Tekerlek Koruma
(Opsiyonel)

*iş, çözüm
arar...*

*tüm sektörler ve ihtiyaçlara yönelik,
farklı yapı tiplerine uygun çözümler*



Yukarı Katlanabilir Orta Dikme



Yukarı katlanabilir orta dikme sayesinde daha geniş açıklıklar için daha ekonomik çözümler.

Profiller



Tekerlek Rayı

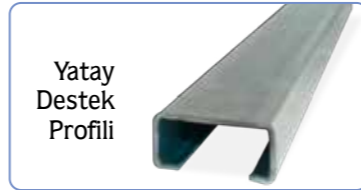

Yatay Destek Profili



Dikey Köşebent

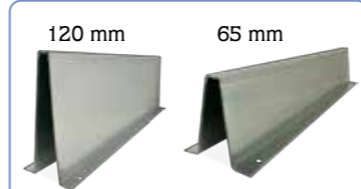

120 mm 65 mm
Panel Güçlendirme Profilleri

Hero model kapılarda tüm tekerlek, tekerlek rayları, dikey köşebent profilleri 3" dir.

Yataklama Tipleri

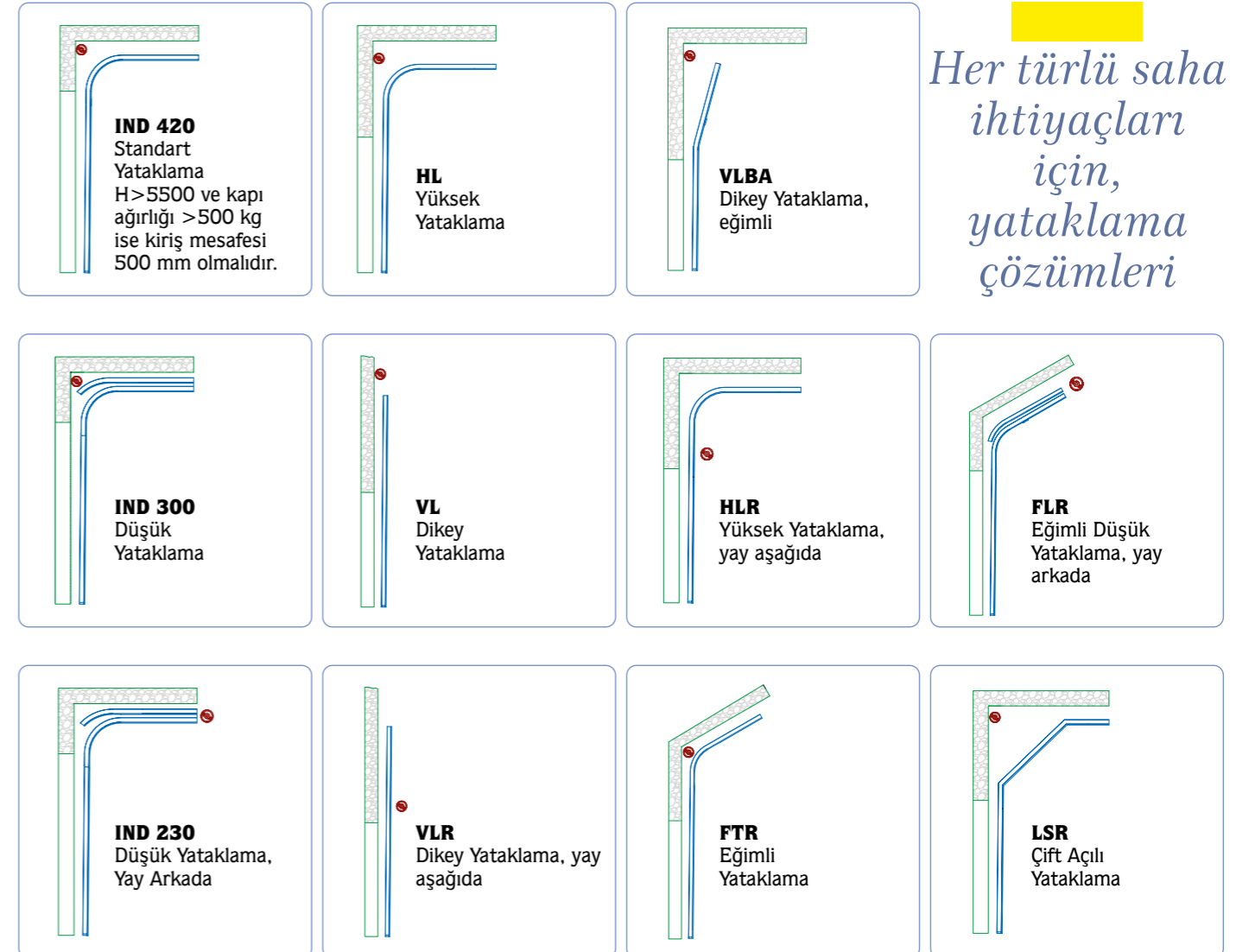

Her türlü saha ihtiyaçları için, yataklama çözümleri

*iş güce
ihtiyaç duyar...*

*ihtiyaçlarınıza tam uyan
çeşitli güç kaynakları*



Çalışma Prensibi

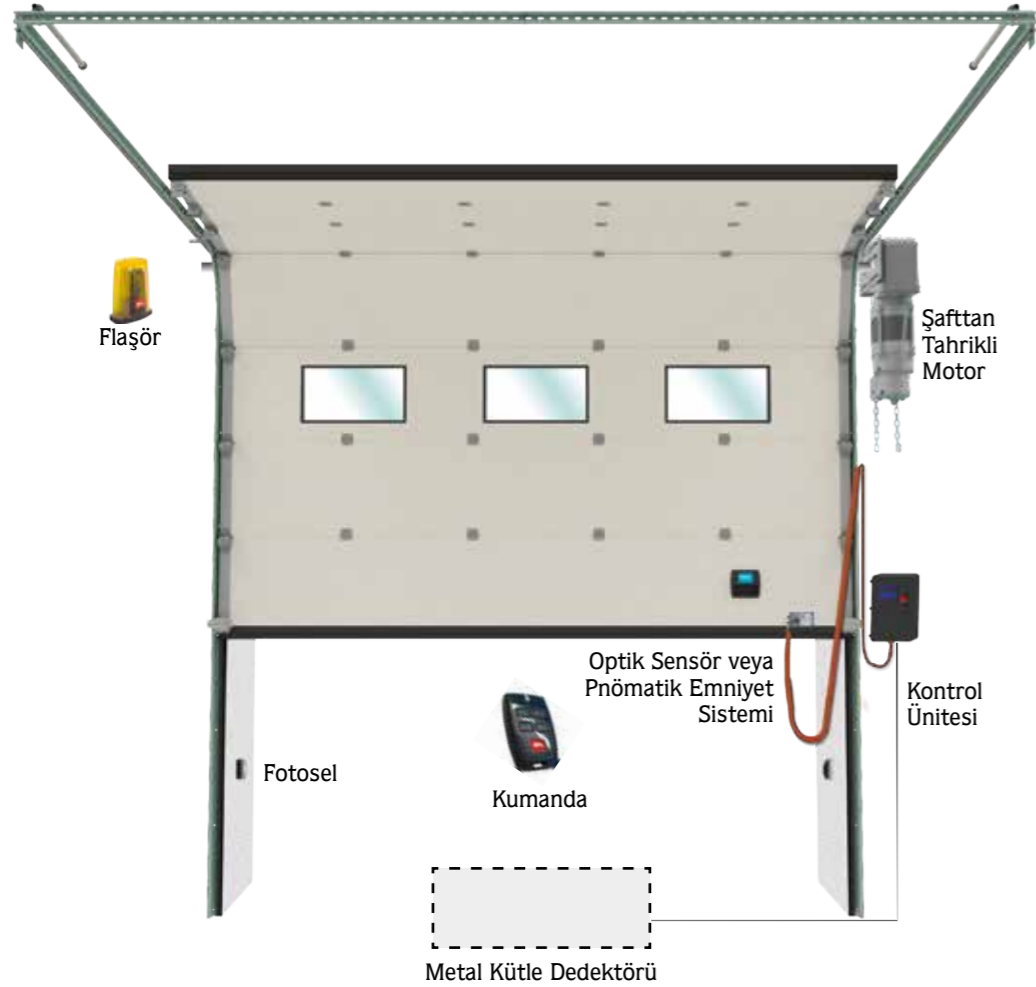

Kontrol Üniteleri



Aksesuarlar



Tecrübe, Üretim, Kalite...

Made in
Türkiye



Sürekli Müşteri Memnuniyeti
Sürekli Kalite



GÖKSU
World Wide Open

GÖKSU Kapı Mekatronik Yapı Teknolojileri San. ve Tic. A. Ş.

Dudullu OSB. 3. Cad. No:14 34775 Ümraniye-İstanbul/TÜRKİYE
Tel: +90 216 466 89 89 E-mail: info@goxu.com.tr



www.goxu.com.tr

KTL001-TR_REV05